

**Powered Personal Transportation**  
**SUPER 800WATT ELECTRIC SCOOTER**



**Product Handbook**

**PLEASE BE SAFE WHEN RIDING . . .**  
**ALWAYS WEAR A HELMET AND OBEY ALL LAWS!**



# IMPORTANT



## BATTERY MAINTENANCE and CHARGING INSTRUCTIONS:

1. You **MUST** Charge completely prior to initial use. (Follow charging instructions in this Product Handbook).
2. Charge immediately after every use.
3. Charge before storage, you must charge every 30 days if not in use.
4. Charge the unit for 6-8 hours after the light on the charger turns green for the initial charge.
5. **DO NOT** allow the batteries to Deep Discharge.
6. For safety purposes, **DO NOT** charge for over 24 hours.
7. Turn the unit **OFF** when not in use.

**Failure to follow proprt CHARING INSTRUCTIONS will  
VOID YOUR WARRANTY!**

**This PRODUCT IS NOT INTENDED FOR EXTREME or  
OFF-ROAD Use! Please take care of your POWERBOARD!**

**DO NOT JUMP or ABUSE THIS PRODUCT!**

**DO NOT RIDE IN WET CONDITIONS!**

**Failure to follow these instruction or abuse will  
VOID YOUR WARRANTY!**

# IMPORTANT

PLEASE READ THIS BEFORE USING THIS PRODUCT

READ THIS FIRST!

## WARNING

This product does not conform to Federal Motor Vehicle Standards and is not intended for operation on public streets, roads or highways. Serious injury can result from the unsafe operations of this product. Operator can minimize these risks by using certain safety equipment such as: safety helmet, goggles, gloves, elbow and kneepads and appropriate footwear.

DO NOT operate this product in traffic, on wet, frozen oily or unpaved surfaces or under the influence of drugs and/or alcohol. Avoid uneven surfaces, potholes, surface cracks and obstacles.

DO NOT use a water hose to clean this product. See Product Handbook for more information.

This product is recommended for riders 16 YEARS OF AGE and older.

## SAFETY

- This product should not be used by persons without excellent vision, balance, coordination, reflex, muscle and bone strength and good decision-making capabilities.
- This product should not be used by minors without adult supervision.
- This product should not be used by persons unwilling or unable to take responsibility for their own actions.
- The user of this product assumes ALL risks associated with its use. To minimize these RISKS, the user must wear safety helmet, goggles, gloves, elbow and knee pads and appropriate footwear.
- This product is ELECTRIC! DO NOT Ride this product in wet conditions, puddles or rainy weather.

## TABLE OF CONTENTS

|  |    |
|--|----|
| BATTERY MAINTENANCE.....               | 2  |
| CHARGING INSTRUCTIONS.....             | 2  |
| GETTING TO KNOW YOUR POWER BOARD ..... | 6  |
| GETTING STARTED.....                   | 6  |
| FOLDING AND STORAGE.....               | 10 |
| CHARGING SYSTEM.....                   | 11 |
| RECOMMENDED TOOLS.....                 | 11 |
| BRAKING SYSTEM.....                    | 11 |
| TIRES AND WHEELS.....                  | 12 |
| ADJUSTING THE HEAD UNIT.....           | 12 |
| CHAIN CARE.....                        | 13 |
| TROUBLESHOOTING GUIDE.....             | 14 |
| OTHER QUESTIONS.....                   | 14 |

## GETTING TO KNOW YOUR POWER BOARD

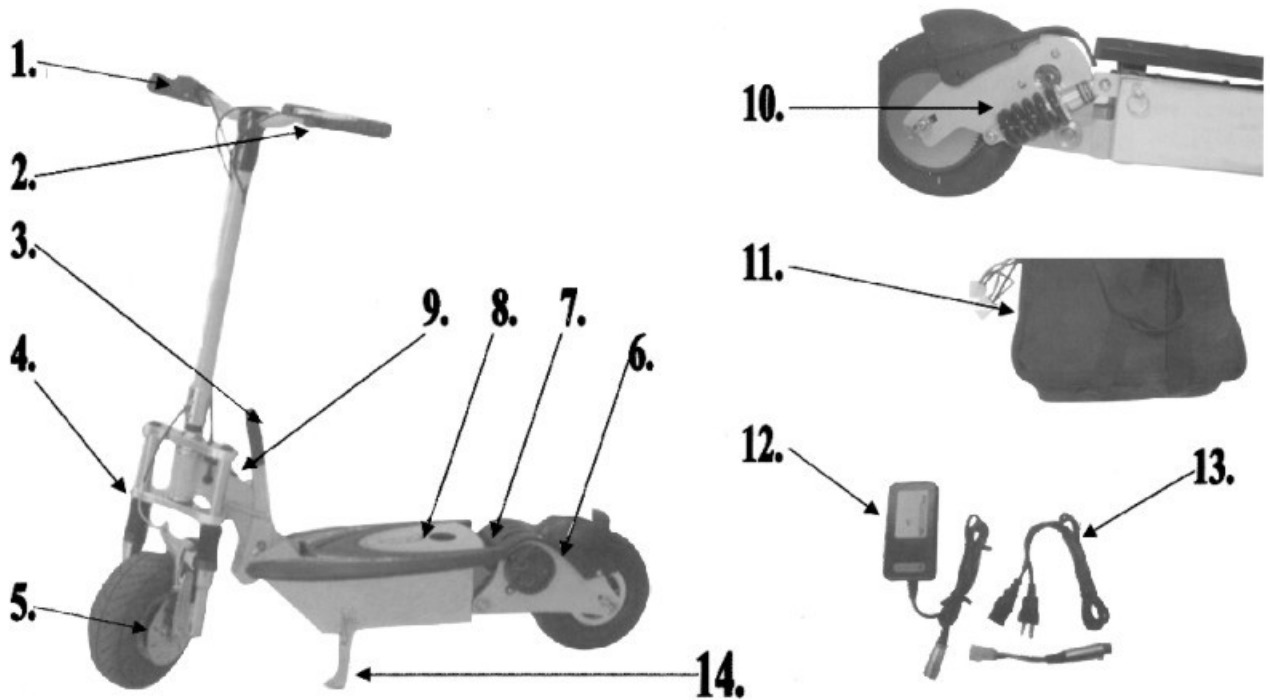

Before operating your Power Board, please get acquainted with all of the features:

- |                                       |                                |
|---------------------------------------|--------------------------------|
| 1. Accelerator Lever (Variable Speed) | 10. Rear Mono-Shock Suspension |
| 2. Brake Lever                        | 11. 36V,12AH Batteries         |
| 3. Folding Handle                     | 12. DC Charger                 |
| 4. Front Suspension                   | 13. Charger Cord               |
| 5. Disc Brake                         | 14. Kickstand                  |
| 6. 800 W Electric Motor               |                                |
| 7. Intergraded Seat Base              |                                |
| 8. Quick Release Deck                 |                                |
| 9. On/Off Switch                      |                                |

## GETTING STARTED

### Unfolding Instruction

1. To unfold the power board , begin by pressing down on the FOLDING HANDLE with one hand while gently pulling up on the handlebar with the other hand.

2. Fully extend the handlebars to their upright position until you feel the mechanism lock into place (Fig. 1).

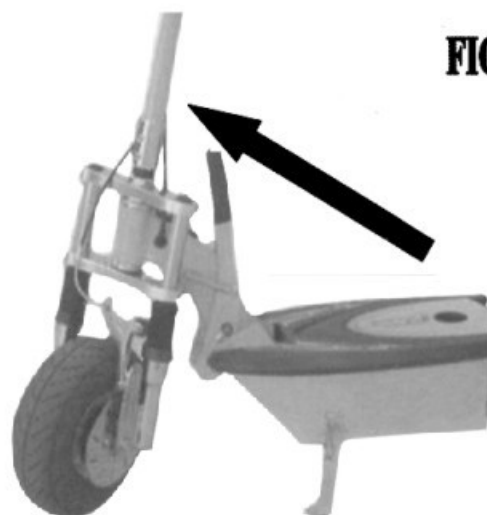

**FIG 1**

### Installing the Handle Bar

Before using your power scooter, loosen the 4 bolts from the Billet Aluminum Stem with the Allen Wrench provided, and then remove the stem cap as shown in Fig 1.

Place handle bar onto the Billet stem with the hole facing down towards the threaded bolt as shown with arrow in Fig 2.

Place the Billet Stem cap on top of the handle bar and tighten the bolts to secure the handle bar onto the stem as shown in Fig 3.

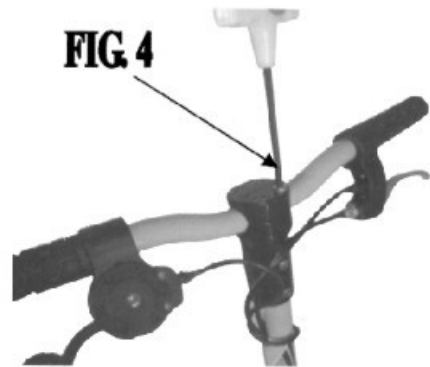
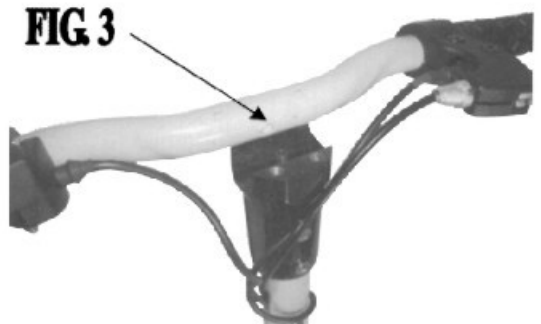
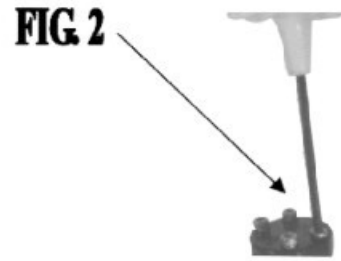

The power scooter has a quick release deck which makes it easier to gain access to the batteries and the pc board. To open simply lift up from the rear of the deck and it will open up towards the handle bar. (Fig. 4)

### Quick Release Deck

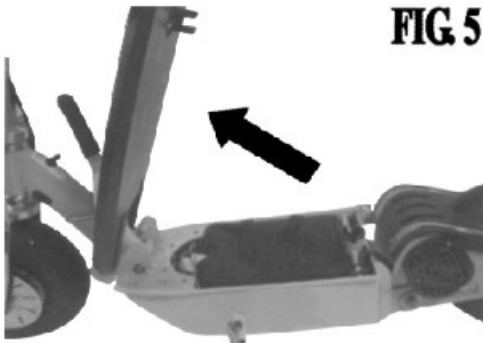

### Intergraded Seat Base

The power scooter comes with a seat base built in to the scooter. Having this base built in to the Scooter will make it easy to install and remove your seat. To install the seat, remove the pin from the side of the scooter. (Fig. 5) Then place the seat post into the base on the deck (Fig.6) and replace the pin in the side of the scooter to secure the post. Place the seat

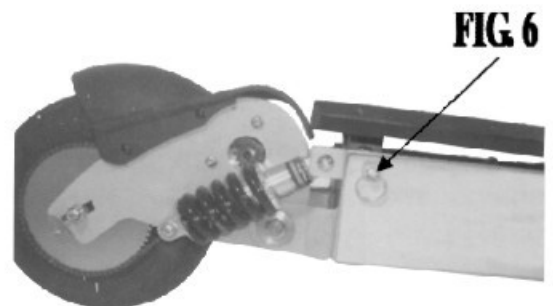

**FIG 7**



on the seat post and adjust the height to your preference and tighten the nut on the underside of the seat. You are ready to use your seat kit.

### **Batteries**

The batteries in the power board are stored in a bag and are removable. This also gives you the option to buy a second pair of batteries which you can swap when a set of batteries starts to run low. (Fig. 8)

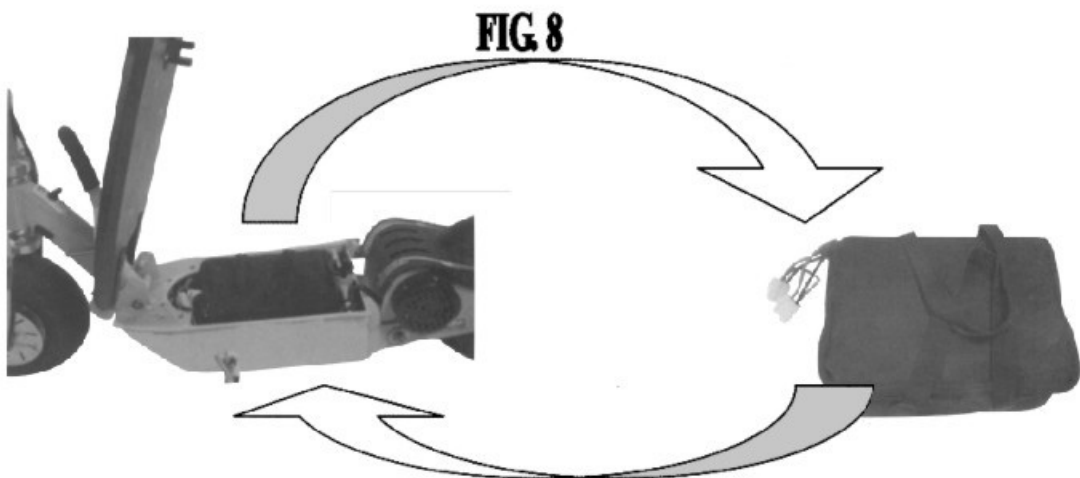

**FIG 8**

### **Charging**

Your power board should come charged out of the box. We still recommends charging the unit for 6-8 hours prior to first use! We also recommends charging your power board after every use and prior to storage. The batteries in the scooter are stored in a bag and are removable. There is one set of wires coming out of the bag. You may plug the charger into either one of the sets of wires. (Fig. 9)

**FIG 9**



**Warning: DO NOT** allow your Powerboard to go into deep discharge! – This will damage the batteries.

### **Charging Your Scooter**

1. Carefully remove the power board from the box and unfold the handle bar.
2. Make sure the unit is turned OFF.

3. Locate the DC CHARGER and plug it into wall(the red light on the charger will turn on showing you have power).
4. Locate the charging port on the side of the scooter and plug in the charger to the scooter.
5. The charging status light will have a red and green light on at the same time indicating that the charging process has started.
7. Once the light on the charger turns green you may remove charger from the side of the scooter.
8. You are now ready to ride the power board.

**Note:** If the light turns green right away, this is because the unit was charged at the factory. Please continue charging for 6-8 hours prior to initial use.

### **Multi-function LED**

The power board comes equipped with a multi-function LED that can tell you the status of your batteries while riding. When the scooter is powered on and it has a full charge over 35V the LED light will be green. Once you begin to ride your scooter and the voltage drops between 33V and 35V the LED will turn yellow to show you will need to charge your scooter soon. Once the Voltage drops under 33V the LED will turn red, this means it is time to charge your scooter. If the volts drop under 31V the LED will blink red, It is necessary for you to stop riding your scooter and charge your batteries immediately to avoid damage your batteries.

The LED also has other function to help you troubleshoot some problems. If you have the throttle lever depressed and you try to turn on the scooter the LED will blink red. This is to keep the scooter from running away when you are not ready. The red LED will also stay solid if there is a problem with your PC board. If there is a problem in the motor the LED will blink yellow. If the motor temperature reaches 221° F the scooter will shut off and the LED light will blink green. If that happens let the motor cool before you attempt to ride again.



## Suspension

The power board is equipped with a front triple clamp suspension and a rear swing arm single suspension. The suspension is adjusted at the factory and does not need to be adjusted. If you feel the suspension is too soft or stiff please take the scooter to your local service center for adjustment. The suspension will give the scooter a smooth ride when riding on rough surfaces.

## Riding

Before going for a joy ride, makes sure that all of the bolts and screws are tightened. Put switch to the ON position. You are now ready to ride your scooter.

Put one foot on the deck of the power board. While pushing off with the other foot, gently squeeze the ACCELERATOR LEVER, on the right side of the handlebars. The power board will begin to move on its own power.

Your power board has a variable speed throttle lever. You can control the speed of the scooter by the amount of pressure you use when depressing the throttle lever. The more you depress the throttle lever the faster you will go.

To stop, release the accelerator handle and depress the BRAKE LEVER (on the left side of the handlebars). Depressing the brake will disengage power to the motor. When the unit feels like it is losing power, or not accelerating to full speed it is ready to be RECHARGE.

**\*NOTE:** At this time, there is still charge in the batteries. Please do not continue to ride! It will damage the batteries..

## **FOLDING AND STORAGE**

When you are done riding the power board you can fold it down for compact storage, carrying and transportation. To fold your scooter simply pull back on the folding handle as you carefully pull down on the handle bars (Fig. 10) (Be carefully not to hit yourself in the head) Fold the handlebar down until you feel the handlebars lock into place. Make sure the POWER SWITCH is in the OFF position and the charger is unplugged from the batteries.

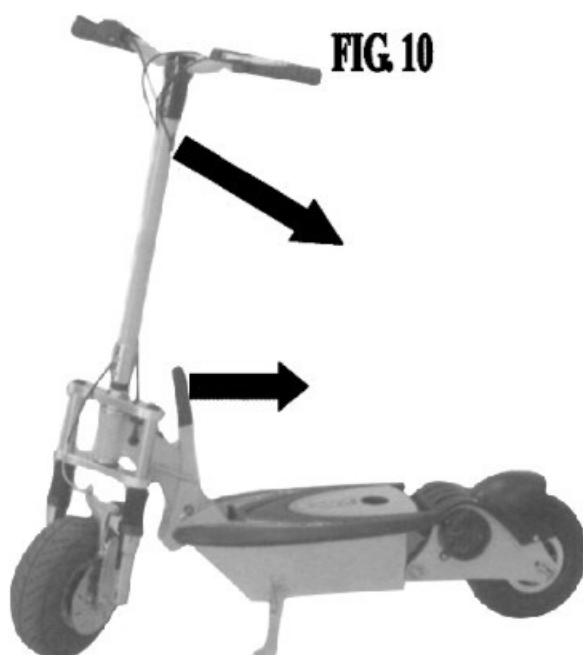

## **CHARGING SYSTEM**

This unit comes standard with a regulated 36V charger.

**NOTE:** It is not advisable to leave your Powerboard plugged in for more than 24 hours.

### **ALWAYS CHARGE YOUR POWERBOARD PRIOR TO STORAGE**

To re-charge your power board simply connect the charger cord to the charging port that is located on the side of the scooter, as described in GETTING STARTED Charging section.

Once the status light on the charger turns green, your Power Board is now fully charged and ready for use.

## **RECOMMENDED TOOLS**

To make adjustments and to service the Power Board you will need the following tools:

**Allen Keys:** 3/4/5/6mm.  
**Wrenches:** 8/10/13/14/17 mm Open and ring combination.  
**Large Adjustable Crescent Wrench**  
**Philips Head Screwdriver**  
**Oil, Grease or Lubricant (such as WD-40)**

## **BRAKING SYSTEM**

The power board uses a front wheel disc/calliper system activated by a hand lever (on the left side of the handlebar). The brake is activated by depressing the BRAKE LEVER with your left hand. The power board is equipped with a controller that temporarily disengages the power to the motor when the BRAKE LEVER is depressed.

Practice braking on a smooth, dry surface to get used to the feeling of the braking system. Braking distance is affected by wet conditions and loose and uneven riding surfaces.

### **Adjusting the Brakes**

The Brakes on the power board should come fully adjusted from the factory. However, it may be necessary to adjust the brakes from time to time.

#### **To adjust the brakes:**

Loosen the tension screw on the Brake Lever by rotating it counter-clockwise until the wheel spins freely.

1. With one hand, depress the brake calliper using your thumb and forefinger. (Fig. 11).
2. With the other hand, adjust the tension screw on the brake line.
  - a. Turn the tension screw clockwise to loosen the brake.
  - b. Turn the tension screw counter-clockwise to tighten the brake.

**FIG 11**

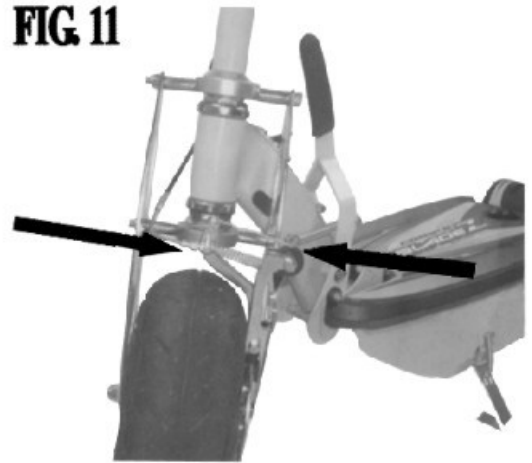

### **Squeaky Brakes**

The brakes may squeak before they are broken in. This is normal and will not affect the function or performance of the brakes. With continued use, the squeak should go away.

### **TIRES AND WHEELS**

The power board uses an identical rim and tires assembly on the front and rear wheels, which means that the tires can be rotated. The wheels are actually two wheel halves (split rim) bolted together to make it easier to remove and replace the tire.

### **Tire Pressure**

It is recommended that the tires be inflated to a maximum of **60 P.S.I.**

**Remove all the air from the tire, prior to loosening the bolts to split the rim.**

### **ADJUSTING THE HEAD UNIT**

The head unit should come adjusted from the factory. However, riding on rough terrain and general use may cause the head unit to become loose over time. It may be necessary to adjust the head unit from time to time.

To adjust the head unit:

1. Rotate the handle bar as far right as it will go to expose the HEAD UNIT
2. Using a large adjustable wrench, gently loosen the lower lock nut. Then tighten the upper nut. Then tighten the lower lock nut to hold the upper nut in place.

\* DO NOT over tighten as it will make it difficult to steer and may DAMAGE THE BEARINGS.

## CHAIN CARE

Proper chain care will increase the life and improve performance of your Power Board. Always keep the chain lubricated and tightened to the proper tension.

### Lubrication

Always keep the chains lubricated with a good chain spray or grease (not chain wax). If the chain is allowed to run dry for a prolonged period it will fail, and the life of the chain will be severely shortened.

### Chain Adjustment

The chain on the power board may need to be adjusted from time to time. The chain should be tight enough not to skip, but have a little bit of play. (About an 8<sup>th</sup> of an inch) If you feel your chain skipping or making a popping noise, adjust the tension immediately.

For regular adjustments:

1. Using a 17mm wrench, loosen the axle bolts on each side of the rear wheel. (Fig. 12)
2. While the axle bolt is loose, using a 10mm wrench loosen the tension bolts behind the rear wheel of the power board and pull the rear wheel backwards to remove the play from the chain (fig. 13).
3. Once the tension is achieved the axle bolt must then be relocked into position and wheel alignment must be checked (while spinning the wheel, visually check that there is an even amount of space on each side of the wheel).

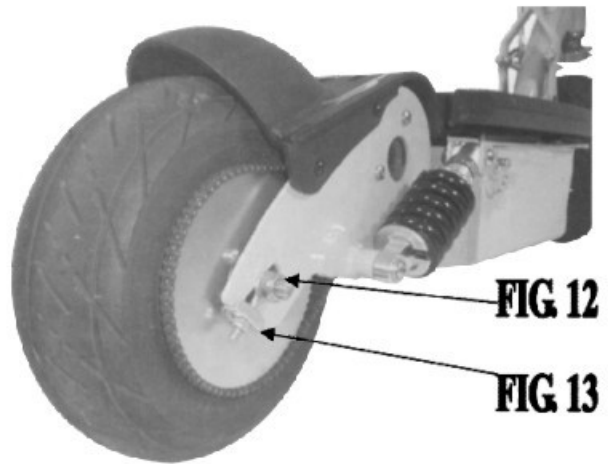

**\*Note: Chains that are run excessively dry or loose can result in sprocket teeth being severely damaged.**

## **TROUBLESHOOTING GUIDE**

The following guide will help assist you in identifying and correcting common problems with your power board:

| <b>Symptoms</b>  | <b>Potential Causes:</b>   | <b>Solutions:</b>   |
|--|--|---|
| The charger light turns green right away                                   | This indicates the batteries are adequately charged. Most units come charged in the box.                                   | Continue to charge the batteries for 6-8 hours prior to initial use.                        |
| Batteries do not hold a charge. Unit does not have specified travel range. | Batteries have reached the end of their useful life or poor polarity between batteries.<br><br>Charger is malfunctioning.  | Replace batteries.<br><br>Replace charger unit.   |
| Unit moves intermittently, or very slow.                                   | Batteries not fully charged or polarity problem.<br><br>Throttle cable is loose.   | Charge or replace batteries.<br><br>Tighten cable.  |
| Unit will not move when throttle lever is activated.                       | Throttle cable is loose.<br><br>Batteries won't fully charged.<br><br>Batteries have reached the end of their useful life. | Tighten cable.<br><br>Replace batteries or charger<br><br>Replace batteries.                |
| Unit stops abruptly during use.  | Circuit breaker has "tripped".   | Allow electric motor to cool and re-set circuit breaker by turning power switch on and off. |

NOTE: You may also refer to the multi-function LED section on page 9 for further troubleshooting.