

MOT-48750 48 Volt 750 Watt Brush DC Motor

Operating Voltage: 48 Volts DC

Rated Power: 750 Watts Continuous Duty

RPM: 2800

Power Wires: 2 (Red, Black)

Power Wire Terminals: 6.3mm White Connector Terminals

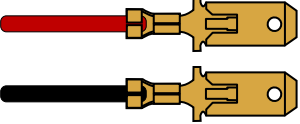
Motor Power Wires		Red to Controller Positive Black to Controller Negative
-------------------	---	--

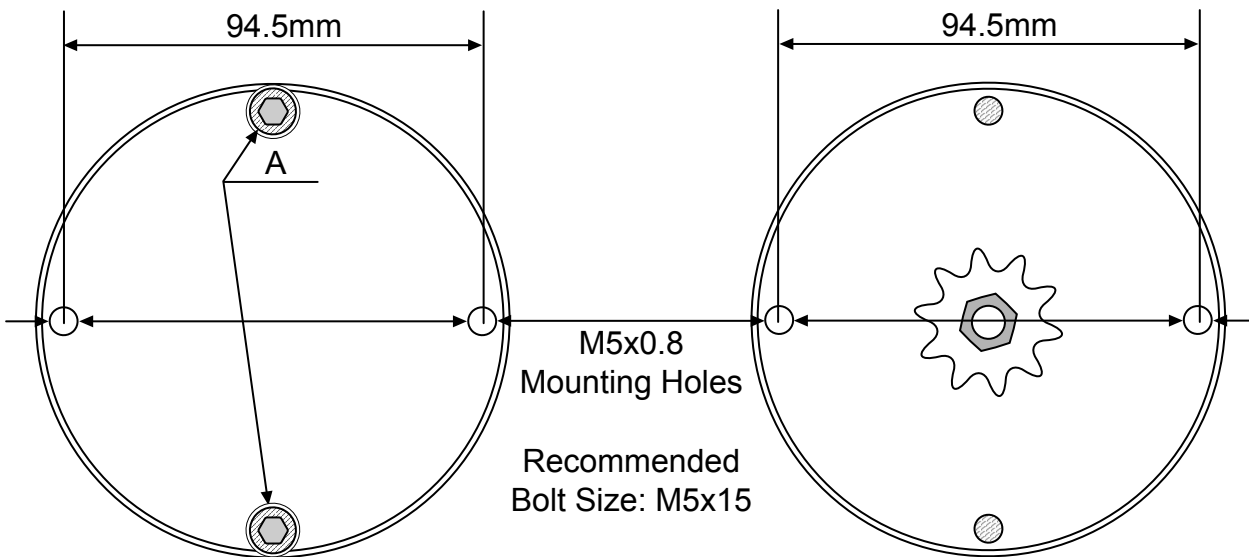
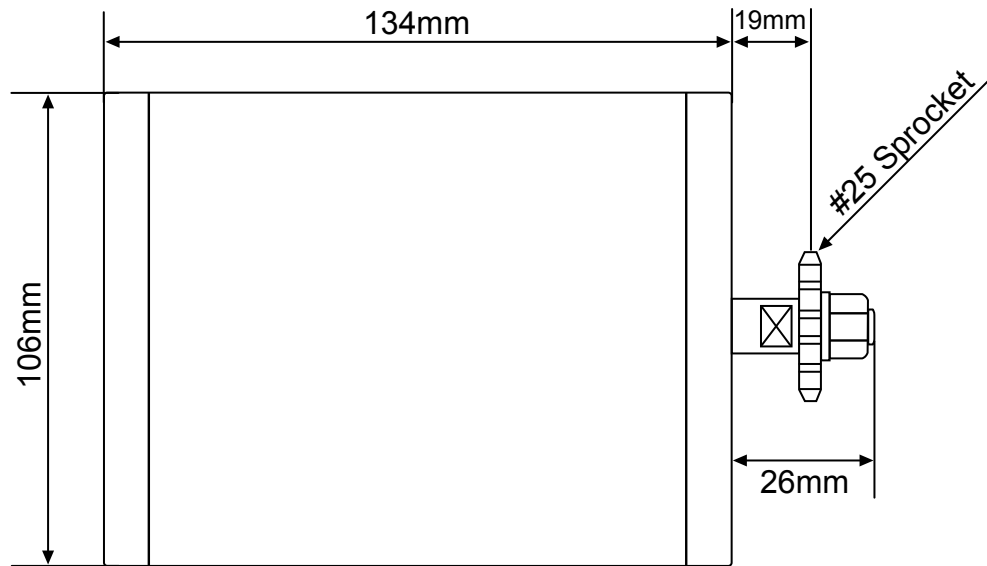

A = Recessed motor assembly bolts provide a flat backplate with no bolt heads protruding out of it.